

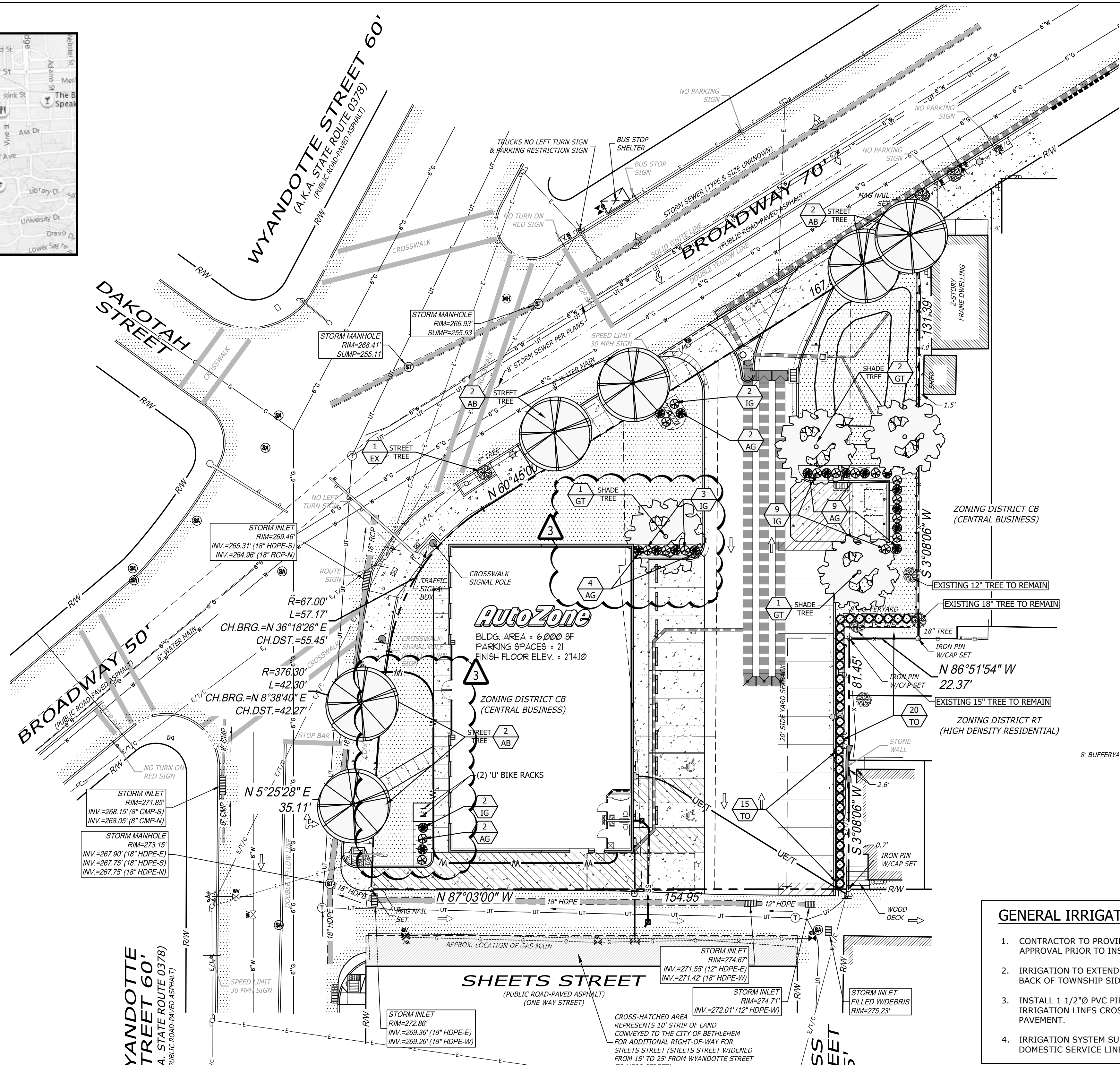

SITE LOCATION MAP
SCALE: 1" = 2,000'

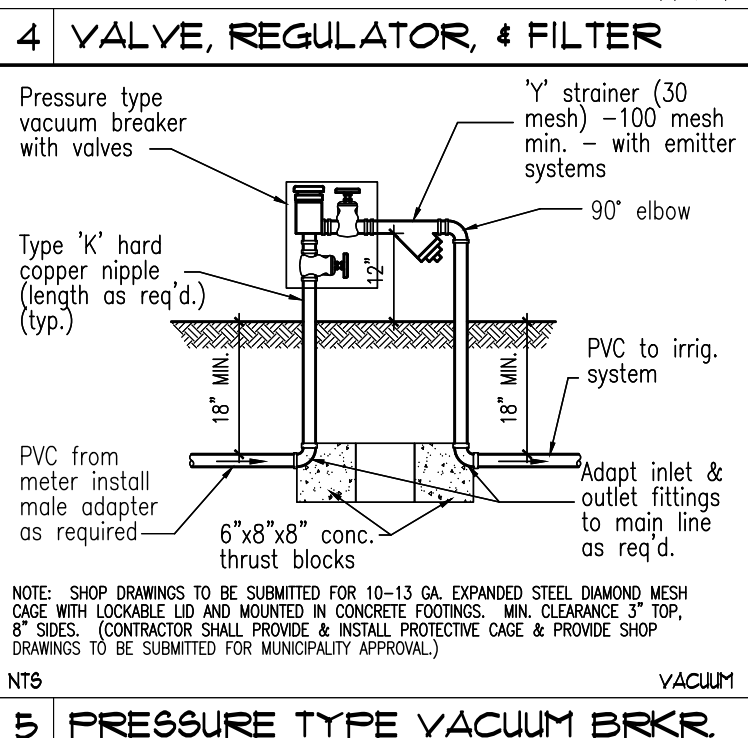

LANDSCAPE REQUIREMENTS			
DESCRIPTION	REQUIRED	PROVIDED	
§ 1318.23 A BUFFER YARD IS REQUIRED IN THE CB DISTRICT ALONG THE DISTRICT BOUNDARIES ADJOINING THE RESIDENTIAL DISTRICT. BUFFER YARD SHALL INCLUDE A DENSE PLANTING OF TREES OR SHRUBS, AT LEAST FOUR (4) FEET IN HEIGHT AT THE TIME OF PLANTING.	YES (15 FT./8 FT., 2 FT.)	YES (8 FT. & 2 FT.)	
§ 1318.23(i)(3) SCREEN PLANTING SHALL BE PLACED SUCH THAT AT MATURITY IT WILL NOT BE CLOSER THAN THREE (3) FEET TO ANY PROPERTY LINE.	YES	NO	
§ 1319.02(j)(1) AN AVERAGE OF ONE (1) STREET TREE SHALL BE PLANTED FOR EVERY THIRTY (30) FEET OF STREET FRONTAGE. WYANDOTTE = 42.3' + 57.17' + 35.11' = 134.58' BROADWAY = 167.59' TOTAL STREET FRONTAGE = 302.17 LF 302.17 ÷ 30 = 11 STREET TREES REQUIRED	11	1 EXISTING 6 NEW W/IN R/W 4 NEW OFF-SITE	
§ 1319.02(j)(2) OFF-STREET PARKING AREAS WHICH PROVIDE PARKING FOR TWENTY (20) OR MORE VEHICLES SHALL BE PROVIDED WITH SHADE TREES OF A TYPE AND SIZE APPROVED BY THE SHADE TREE COMMISSION. PROVIDE ONE (1) SHADE TREE FOR EVERY FIFTEEN (15) SURFACE PARKING SPACES. 21 SPACES ÷ 15 = 2 TREES REQUIRED	2	2	
§ 1319.02(h) IN ANY PARKING AREA OF FIVE (5) OR MORE SPACES ABUTTING A RESIDENTIAL DISTRICT, ALL SPACES SHALL BE PROVIDED WITH EVERGREEN PLANTING AT LEAST FOUR (4) FEET IN HEIGHT AT TIME OF PLANTING.	YES	YES	
PROVIDE ONE (1) NEW TREE FOR THE REMOVAL OF ANY EXISTING TREE 8" Ø OR GREATER.			NUMBER OF TREES REMOVED 4
§ 1349.08 - LANDSCAPED OFF-STREET PARKING & LOADING AREA COMPLIANCE AREAS SHALL HAVE A MINIMUM OF TEN (10%) PERCENT OF THE AREA REPRESENTED BY APPROVED PLANTINGS. OFF STREET PARKING AND LOADING AREAS 11,521 SQUARE FEET OF PARKING AND LOADING AREA. 11,521 x 0.10 = 1,152 SF OF PLANTINGS REQUIRED PROPOSED TREES, 4 MEDIUM TREES x 50 SF = 600 SF SHRUBS / ORNAMENTAL / PERENNIAL = 580 SF TOTAL SQUARE FOOTAGE PROVIDED = 1,180 SF			1,152 SF OF PLANTING REQUIRED 1,180 SF OF PLANTING PROVIDED

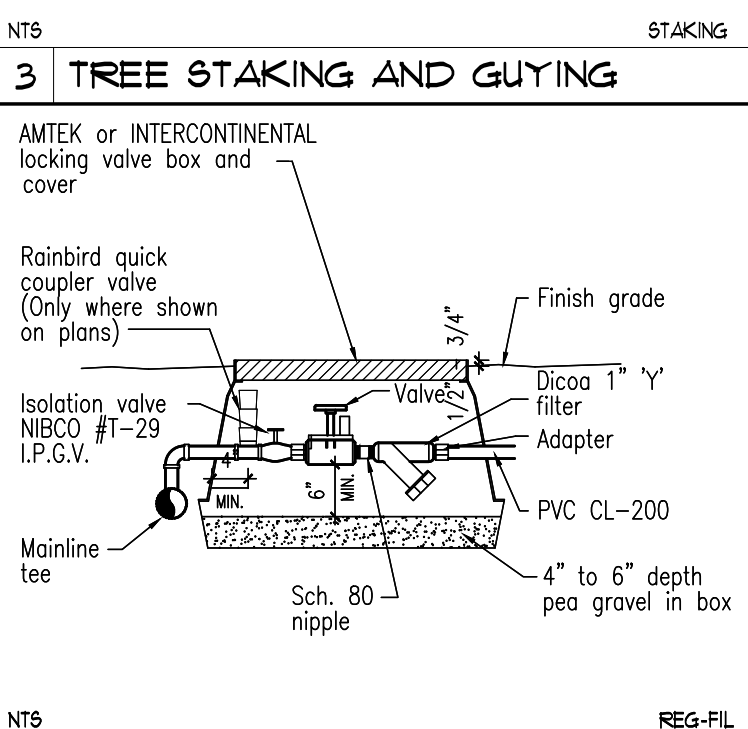
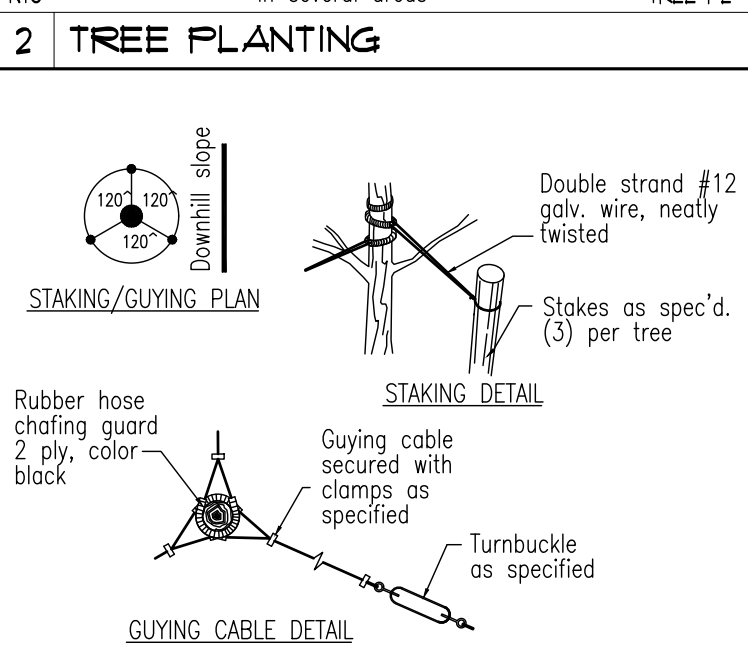
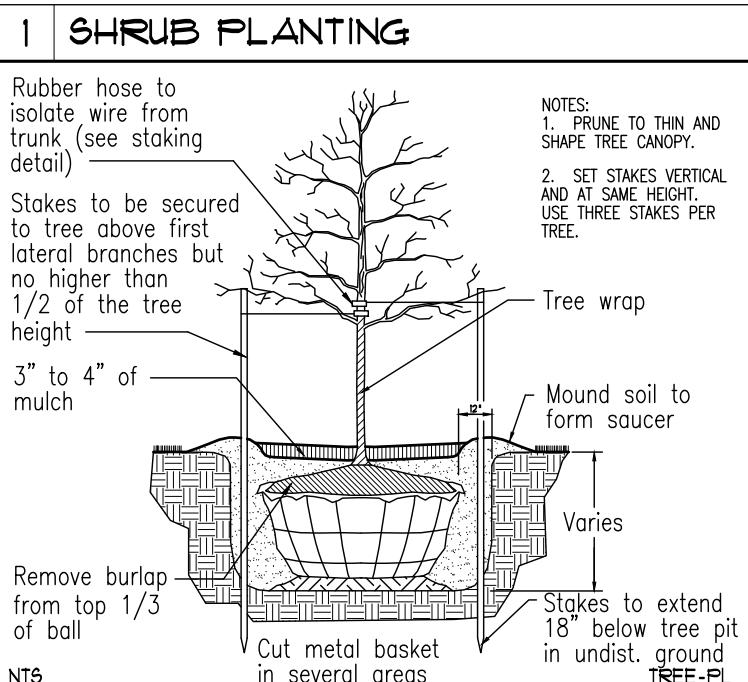
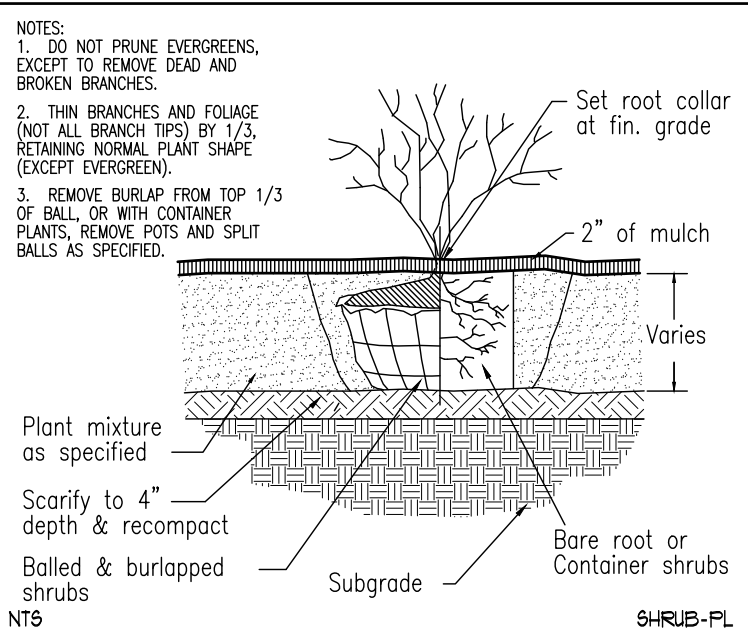
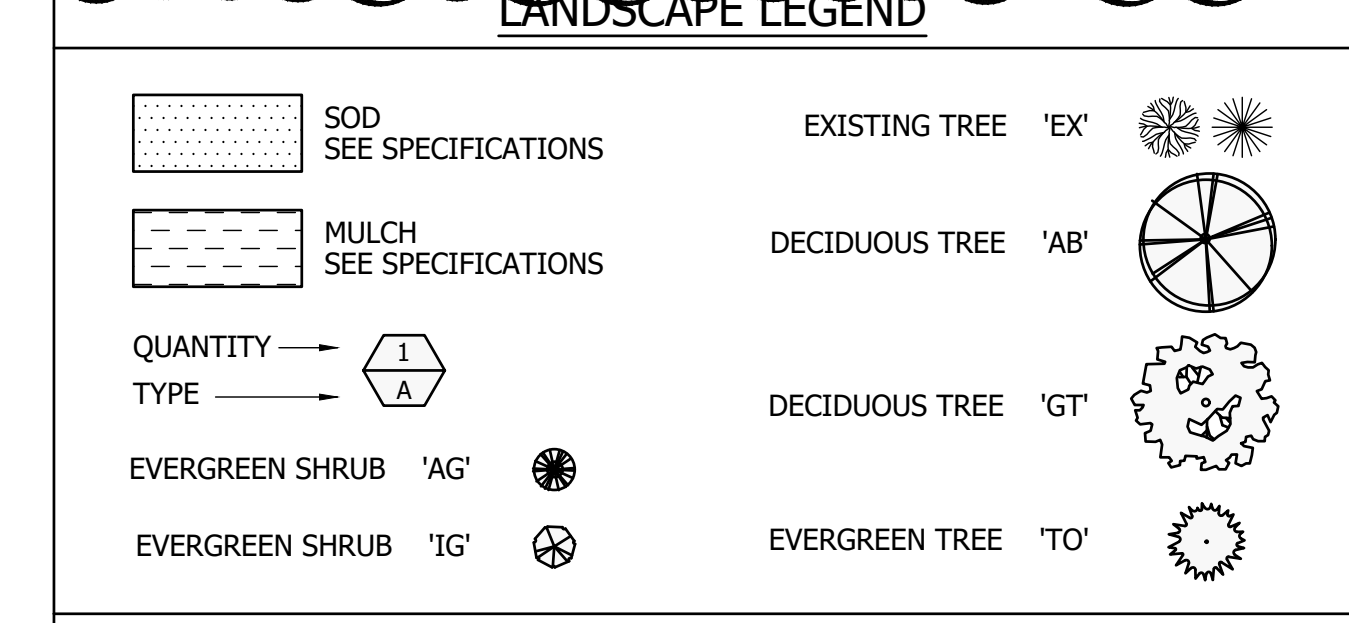

PLANT LIST					
QTY.	KEY	BOTANICAL/COMMON NAME	MATURE SIZE	ROOT TYPE	REMARKS
6	AB	ACER CAMPESTRE HEDGE MAPLE	2 1/2" CAL.	B & B	STREET TREE USE CITY OF BETHLEHEM TREE PLANTING DETAIL THIS SHEET
15	AG	ABELIA GRANDIFLORA GLOSSY ABELIA	48" MIN. HGT.	B & B	EVERGREEN SCREEN
4	GT	GLEDTISIA TRIACANTHOS THORNLESS HONEY LOCUST	2 1/2" CAL.	B & B	SHADE TREE
14	IG	ILEX GLABRA 'NORDIC' INKBERRY	48" MIN. HGT.	B & B	EVERGREEN SCREEN
35	TO	THUJA OCCIDENTALIS CONICAL ARBORVITAE	48" MIN. HGT.	3.6 GAL.	EVERGREEN SCREEN

- GENERAL NOTES**
- ALL LANDSCAPE AREAS TO BE GRASS COMMON TO REGION EXCEPT WHERE OTHER PLANT MATERIAL IS CALLED FOR.
 - ALL HEAVILY PLANTED AREAS TO RECEIVE AUTOMATIC PERMANENT IRRIGATION, CONTRACTOR TO PROVIDE DESIGN DRAWINGS FOR APPROVAL PRIOR TO INSTALLATION.
 - ALL TREES AND SHRUBS TO BE PLANTED IN MULCH BEDS WITH EDGE STRIPS TO SEPARATE TURF GRASS AREAS.
 - GRASS & IRRIGATION TO EXTEND FROM PROPERTY LINES TO BACK OF LOCAL SIDEWALKS AND/OR CURBS.
 - INSTALL 1 1/2" DIA. PVC PIPE SLEEVES WHERE IRRIGATION LINES CROSS OR ARE UNDER PAVEMENT.
 - FOR ANY LANDSCAPE AREA SO DESIGNATED TO REMAIN WHETHER ON OR OFF SITE, REMOVE WEEDS, ROCKS, CONSTRUCTION ITEMS, ETC., THEN SCARIFY AREA, RESEED, AND FERTILIZE. R.O.W. CURB AND GUTTERS ARE TO BE CLEANED OF DEBRIS.
 - FINISHED GRADES IN LANDSCAPE ISLANDS SHALL BE INSTALLED SO THAT THEY ARE 1" LOWER THAN THE TOP OF THE SURROUNDING CURB.
 - FOR ANY TREE LOCATED NEAR A DRIVEWAY, PRUNE LOWER BRANCHES TO PROVIDE A MINIMUM 6'-0" HIGH CLEAR SIGHT LINE FROM GRADE.
 - ALL STREET TREES TO BE INSTALLED IN TREE WELLS PER CITY OF BETHLEHEM SPECIFICATIONS.

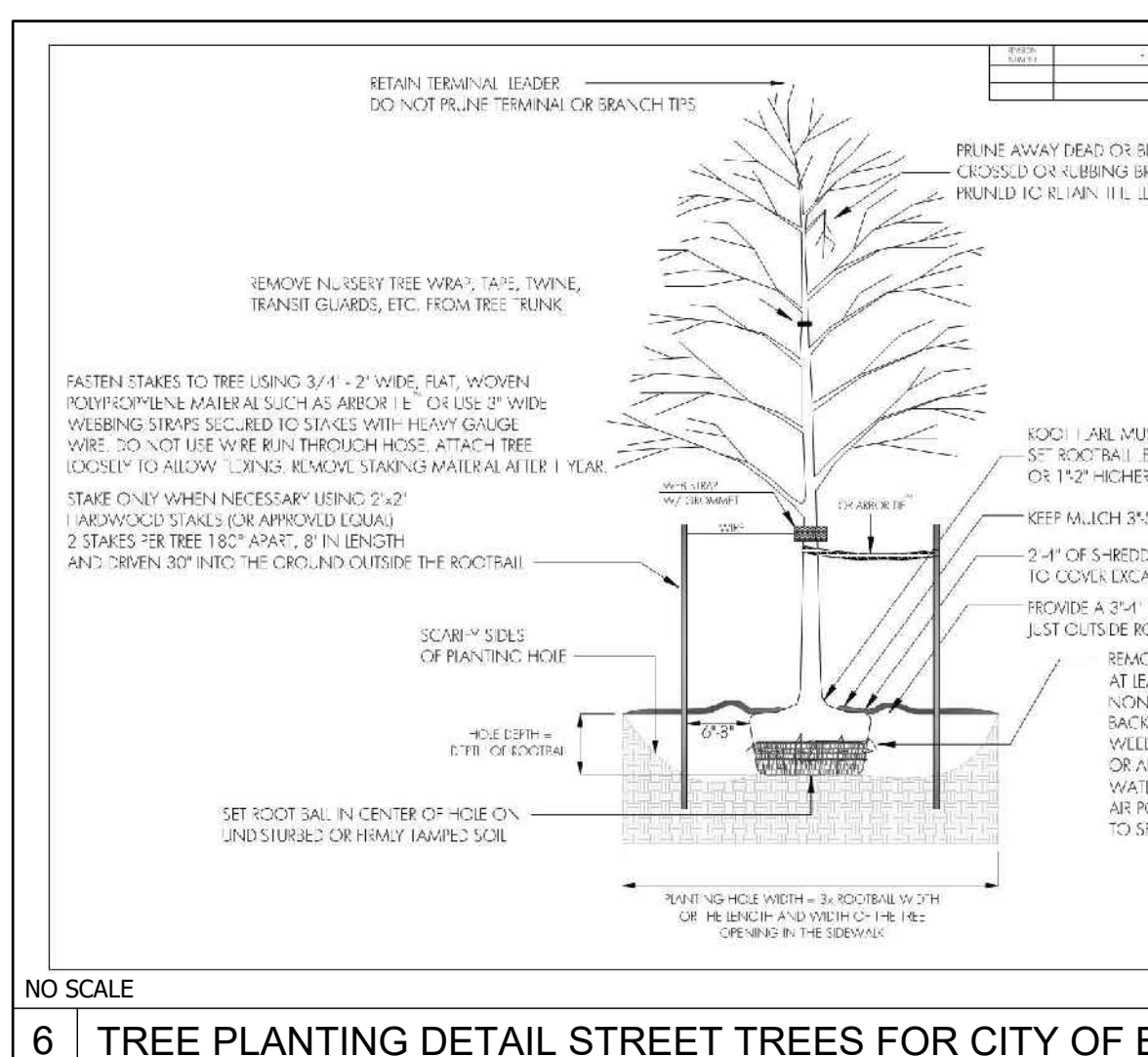

Owner / Developer:
AZ Bethlehem, LLC
P.O. BOX 1908
MEDIA, PA 19063

Prepared For:
AutoZone
Store No.: 1400
501 WYANDOTTE STREET
CITY OF BETHLEHEM, COUNTY OF NORTHAMPTON
COMMONWEALTH OF PENNSYLVANIA

SCALE: 1" = 20'-0"

REVISIONS

NO.	DATE	DESCRIPTION
1.	02/24/2021	PER CITY COMMENTS
2.	04/15/2021	PER CITY COMMENTS
3.	05/05/2021	PER CITY COMMENTS
4.		
5.		
6.		
7.		

ARCHITECT: LE
DRAFTSMAN: CWT
CHECKED BY: CAD
DATE: 10-23-2020
PROTOTYPE SIZE: 6w2

L1.0